

Varenummer: 03465030

Beskrivelse: Fluro Ledhoved EI 30D-2RS

Mål

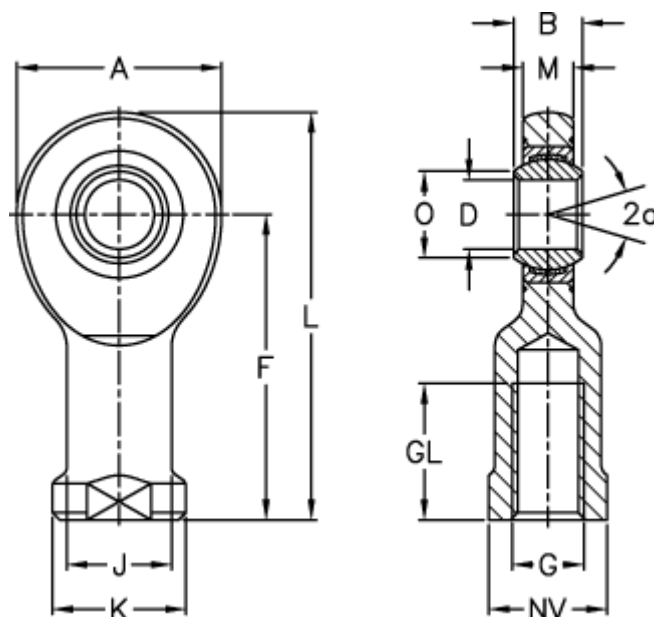

A	= 73	J	= 40
a (grader)	= 6	K	= 50
B	= 22	L	= 146.5
D	= 30	M	= 19
Dynamisk træk kN	= 66	NV	= 41
F	= 110	O	= 34.2
g	= M30x2	Statisk træk kN	= 124
GL	= 56	Vægt	= 930